

Features:

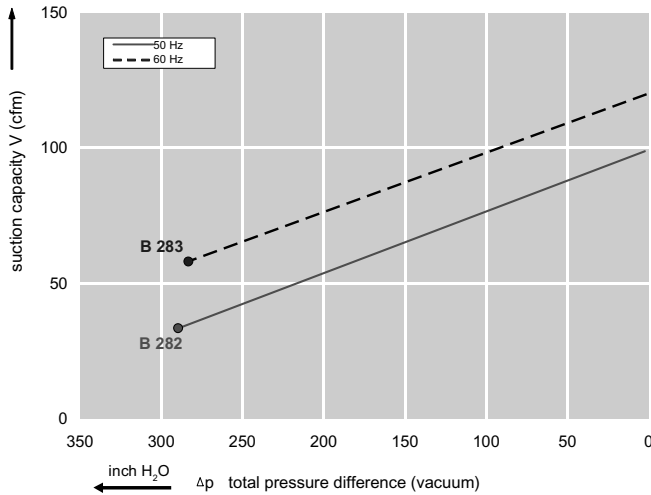

- Cooler running, outboard bearing provides maintenance-free operation
- Environmentally friendly oil-free technology
- Extremely quiet operation
- All motors are standard TEFC with Class F insulation, UL recognized, CE Compliant
Explosion-Proof motors available
- Custom construction blowers are available
- Rugged die cast aluminum construction

Performance curve for Vacuum pump



Performance curve for Compressor

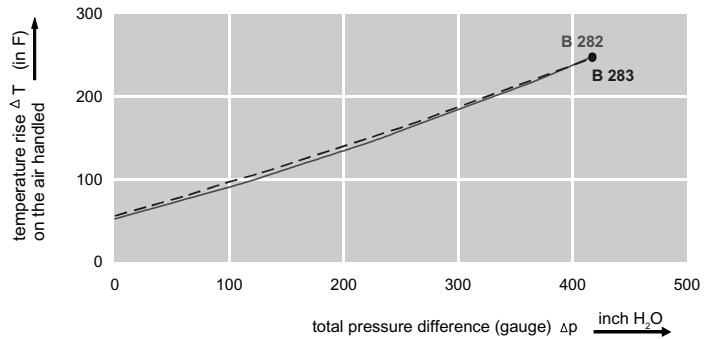
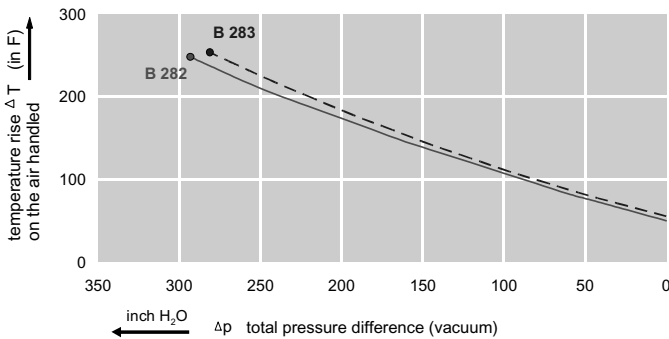
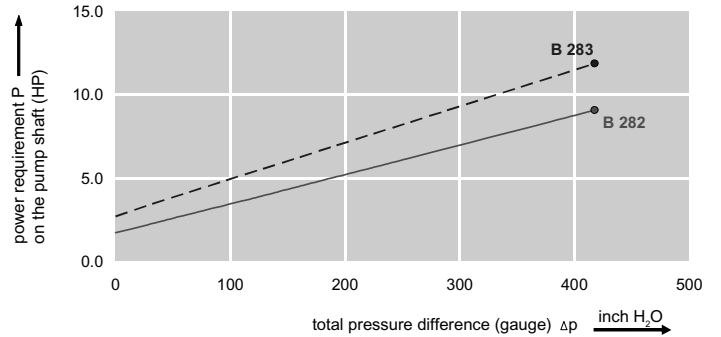
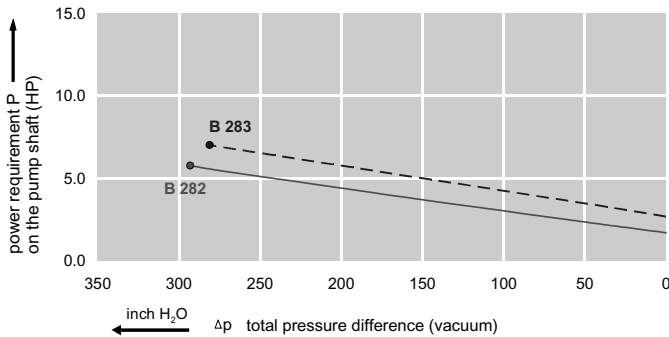
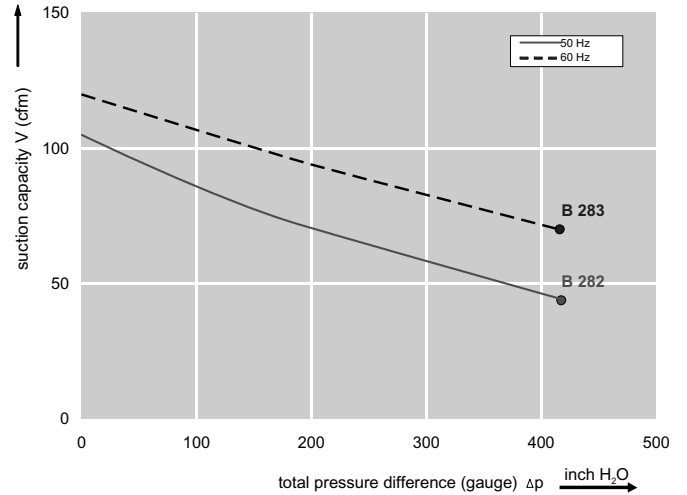

Dimensions: (inches)

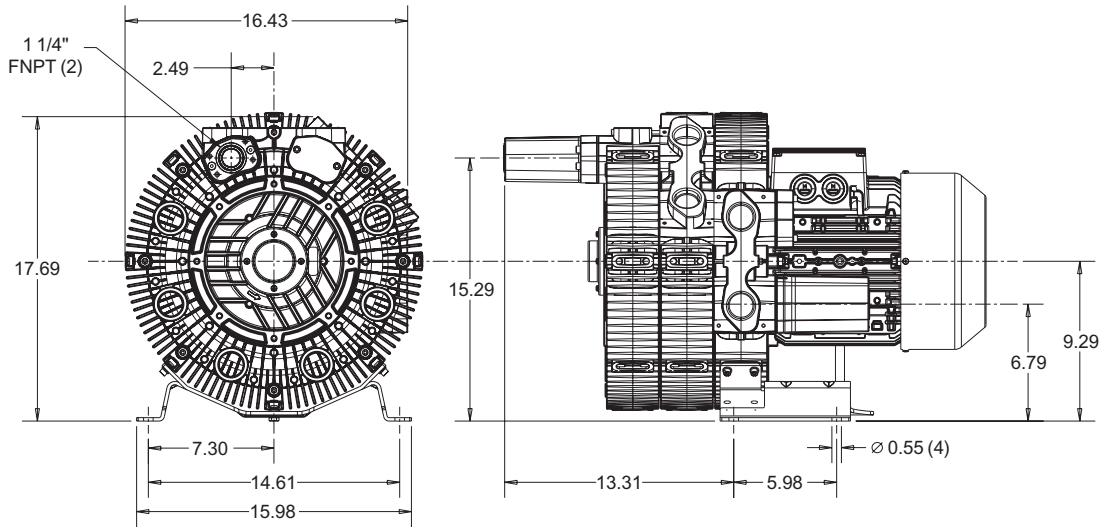

Recommended Accessories:

Relief valve:

VC51Z (Vacuum)
PC51Z (Pressure)

Filter:

ATF-125-1337
(Vacuum)
AF-S20-125-10
(Pressure)

Specifications subject to change without notice. Please contact factory for specification updates.

Selection & Ordering Data - Type 3BA7630

Curve No.	Order No.	Fre- quency Hz	Rated power HP	Input voltage		Input current A	Permissible total differential pressure		Sound pressure level dB(A)	Weight lbs	
				V			Vacuum inch H2O	Compressor inch H2O			
3~ 50/60 Hz IP55 insulation material class F											
B 282	3BA7630-0AT66	50	10.05	200D ... 240D	345Y ... 415Y	29.0D	16.7Y	-293	418	72	189
B 283	3BA7630-0AT66	60	11.52	220D ... 250D	415Y ... 460Y	27.5D	15.0Y	-281	418	76	189

Suitable for 208 Volt Operation