

Features:

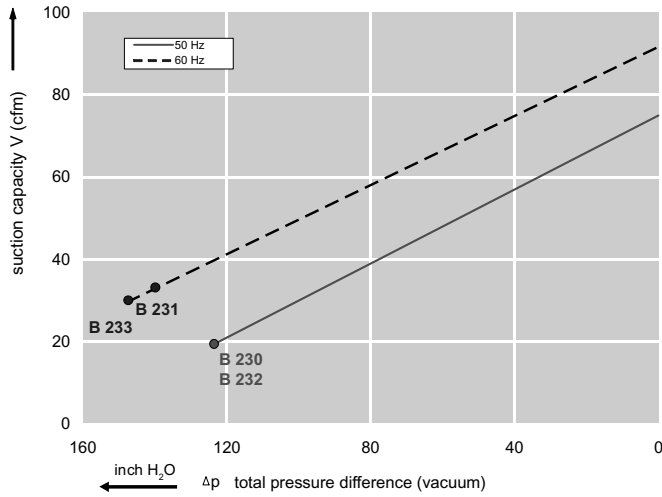

- Cooler running, outboard bearing provides maintenance-free operation
- Environmentally friendly oil-free technology
- Extremely quiet operation
- All motors are standard TEFC with Class F insulation, UL recognized, CE Compliant
Explosion-Proof motors available
- Custom construction blowers are available
- Rugged die cast aluminum construction

Performance curve for Vacuum pump



Performance curve for Compressor

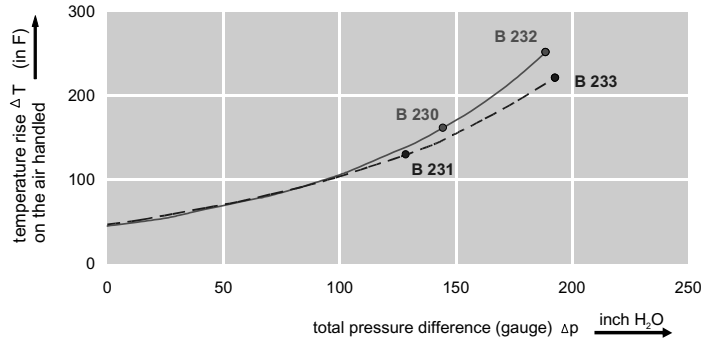
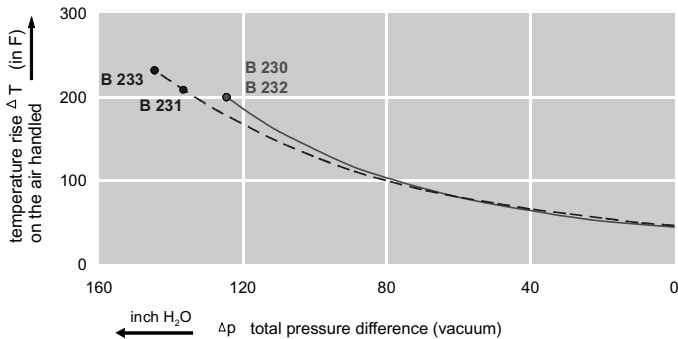
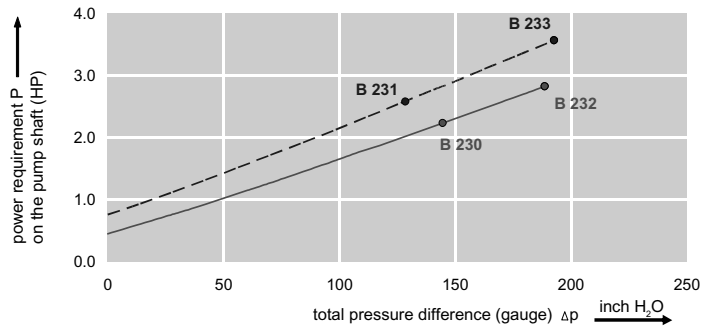
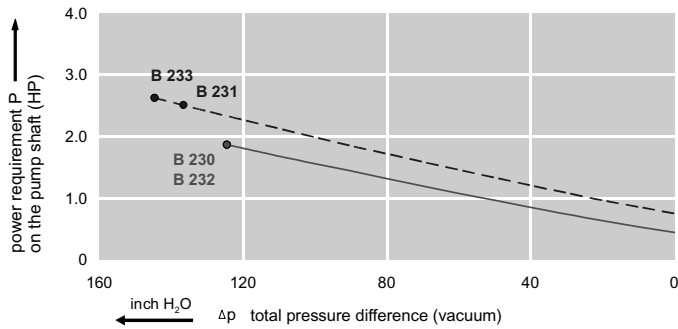
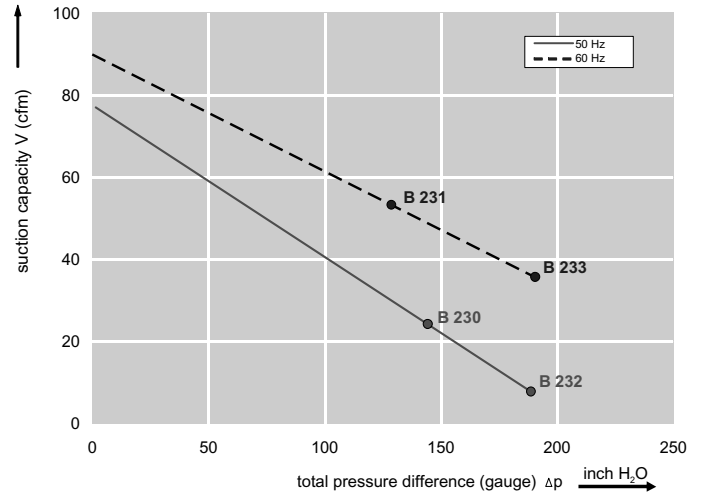

Dimensions: (inches)

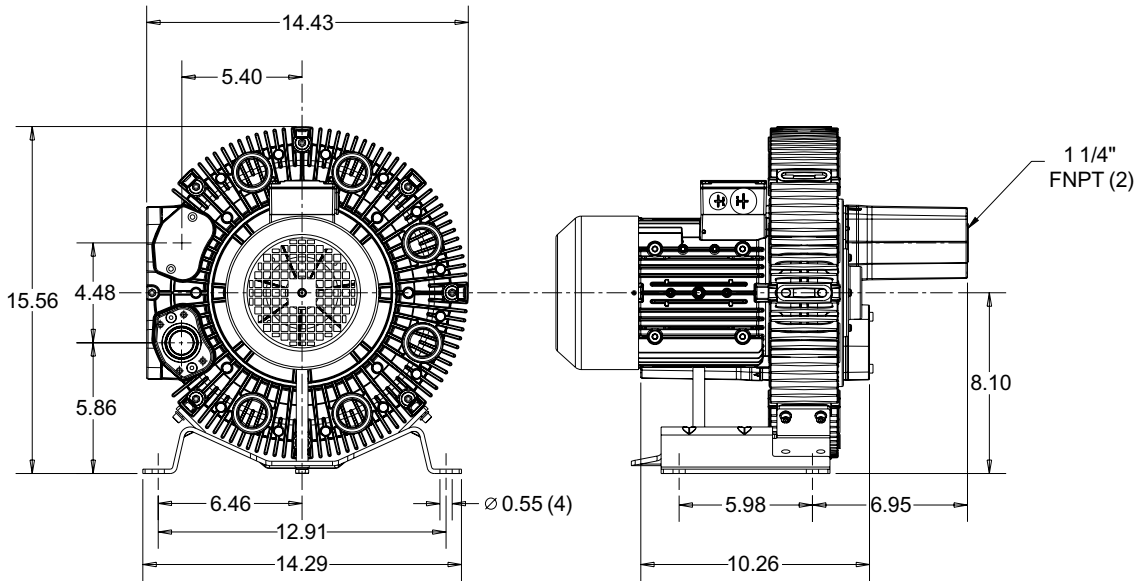

Recommended Accessories:

Relief valve:

VC51Z (Vacuum)
PC51Z (Pressure)

Filter:

ATF-125-1337
(Vacuum)
AF-S20-125-10
(Pressure)

Specifications subject to change without notice. Please contact factory for specification updates.

Selection & Ordering Data - Type 3BA7510

Curve No.	Order No.	Fre- quency Hz	Rated power HP	Input voltage		Input current		Permissible total differential pressure		Sound pressure level dB(A)	Weight lbs
				V		A		Vacuum inch H2O	Compressor inch H2O		
3~ 50/60 Hz IP55 insulation material class F											
B 230	3BA7510-0AT16	50	2.01	200D ... 240D	345Y ... 415Y	7.5D	4.3Y	-124	145	64	57
B 231	3BA7510-0AT16	60	2.75	220D ... 250D	415Y ... 460Y	7.5D	4.4Y	-136	128	68	57
B 232	3BA7510-0AT26	50	2.95	200D ... 240D	345Y ... 415Y	9.7D	5.6Y	-124	189	64	64
B 233	3BA7510-0AT26	60	3.42	220D ... 250D	415Y ... 460Y	9.0D	5.3Y	-145	193	68	64

Suitable for 208 Volt Operation