

Features:

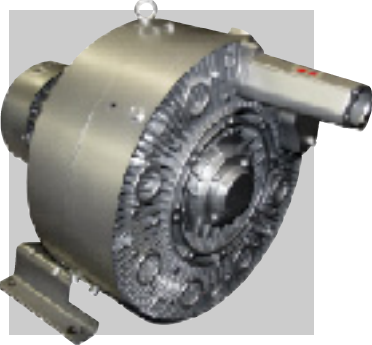

- Cooler running, outboard bearing provides maintenance-free operation
- Environmentally friendly oil-free technology
- Extremely quiet operation
- All motors are standard TEFC with Class F insulation, UL recognized, CE Compliant
Explosion-Proof motors available
- Custom construction blowers are available
- Rugged die cast aluminum construction

Performance curve for Vacuum pump

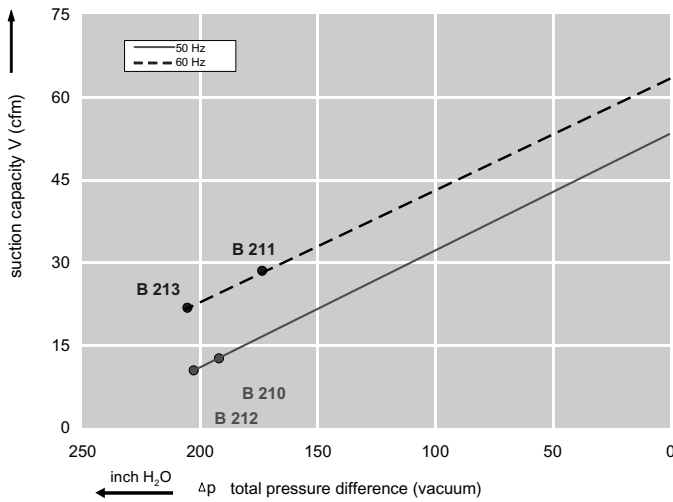

Performance curve for Compressor

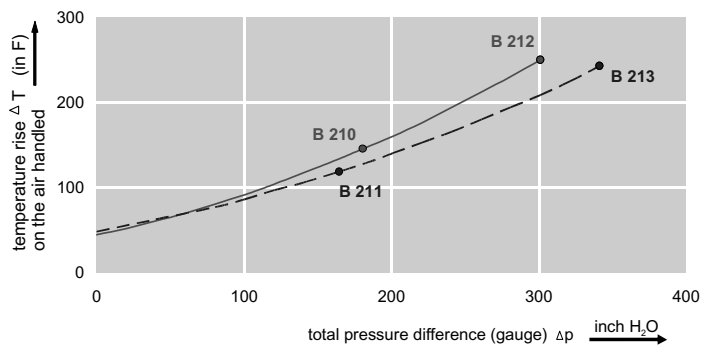
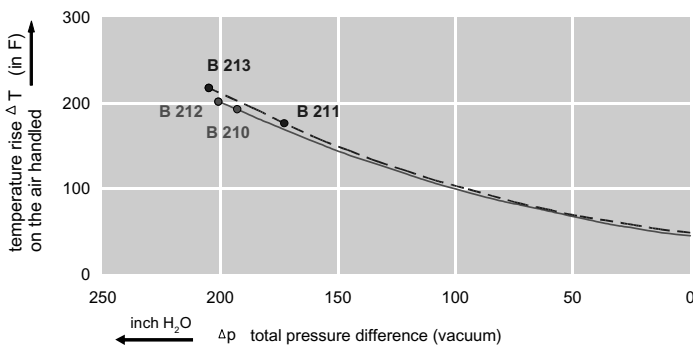
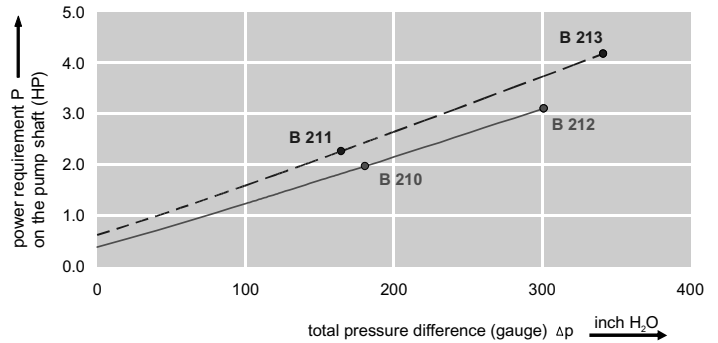
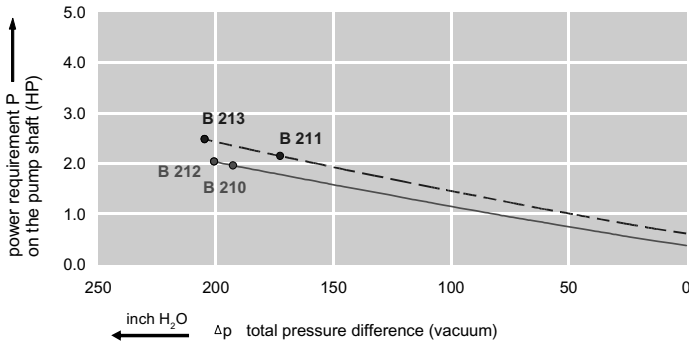
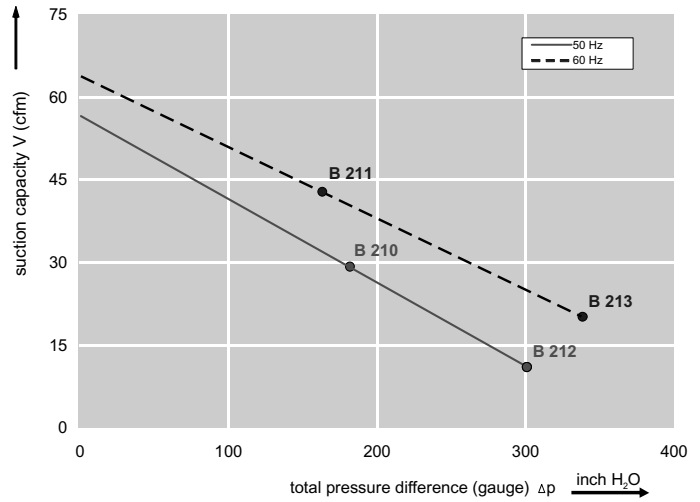

Dimensions: (inches)

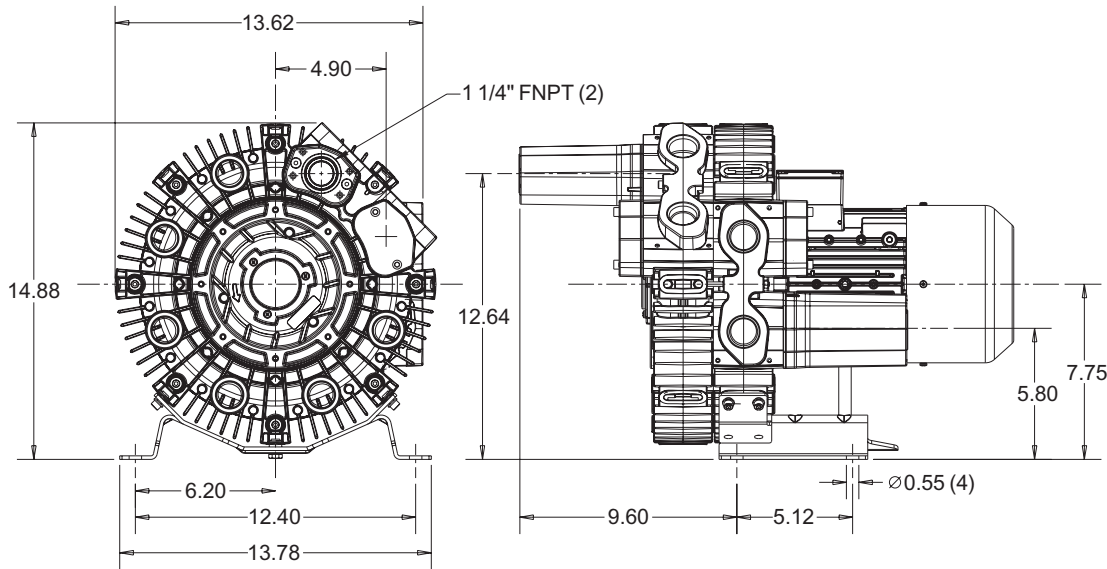

Recommended Accessories:

Relief valve:

VC51Z (Vacuum)
PC51Z (Pressure)

Filter:

ATF-125-1337 (Vacuum)
AF-S20-125-10 (Pressure)

Specifications subject to change without notice. Please contact factory for specification updates.

Selection & Ordering Data - Type 3BA7420

Curve No.	Order No.	Fre- quency Hz	Rated power HP	Input voltage		Input current		Permissible total differential pressure		Sound pressure level dB(A)	Weight lbs
				V		A		Vacuum inch H2O	Compressor inch H2O		
3~ 50/60 Hz IP55 insulation material class F											
B 210	3BA7420-0AT26	50	2.01	200D ... 240D	345Y ... 415Y	7.5D	4.3Y	-193	181	61	73
B 211	3BA7420-0AT26	60	2.75	220D ... 250D	415Y ... 460Y	7.5D	4.4Y	-173	165	66	73
B 212	3BA7420-0AT56	50	4.42	200D ... 240D	345Y ... 415Y	13.0D	7.5Y	-201	301	61	86
B 213	3BA7420-0AT56	60	5.09	220D ... 250D	415Y ... 460Y	13.5D	7.8Y	-205	341	66	86

Suitable for 208 Volt Operation