

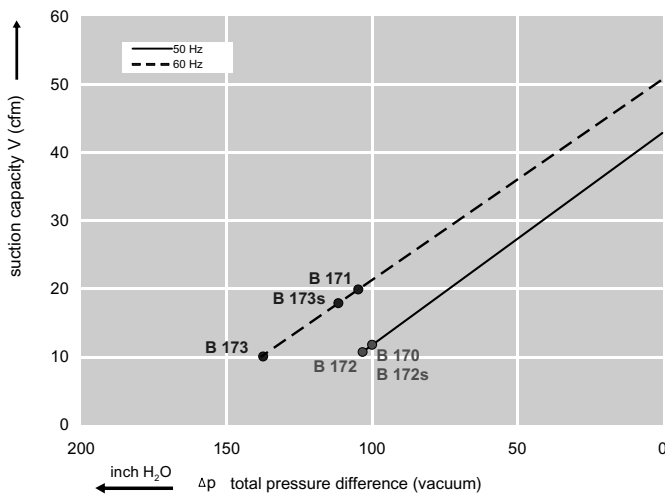

Features:

- Cooler running, outboard bearing provides maintenance-free operation
- Environmentally friendly oil-free technology
- Extremely quiet operation
- All motors are standard TEFC with Class F insulation, UL recognized, CE Compliant
Explosion-Proof motors available
- Custom construction blowers are available
- Rugged die cast aluminum construction

Performance curve for Vacuum pump



Performance curve for Compressor

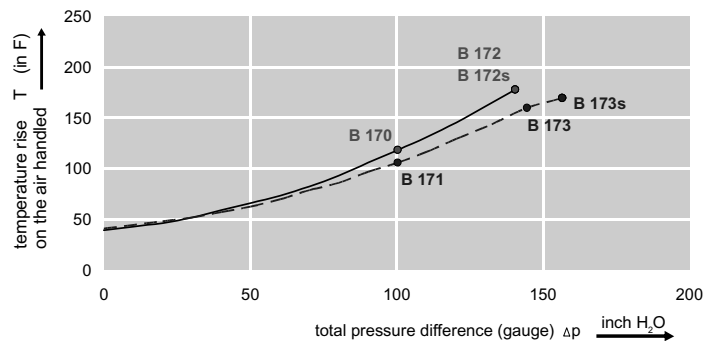
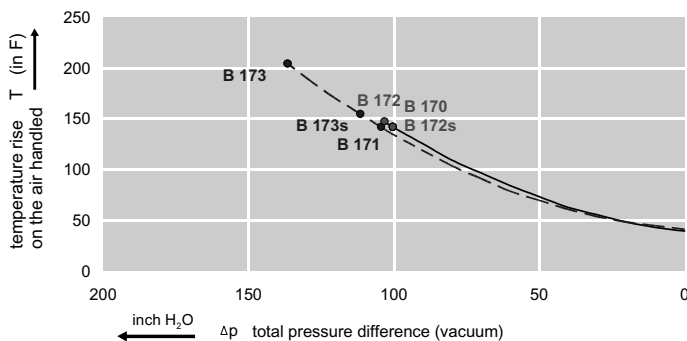
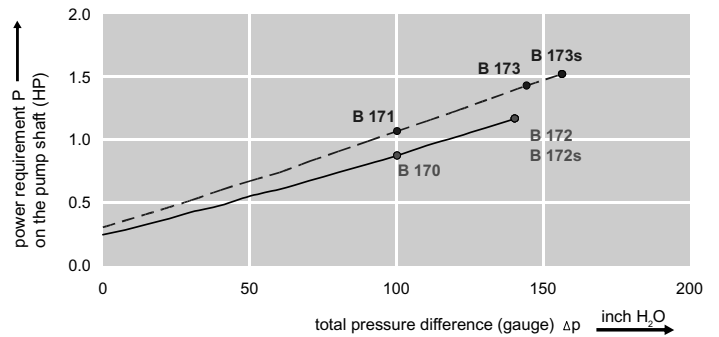
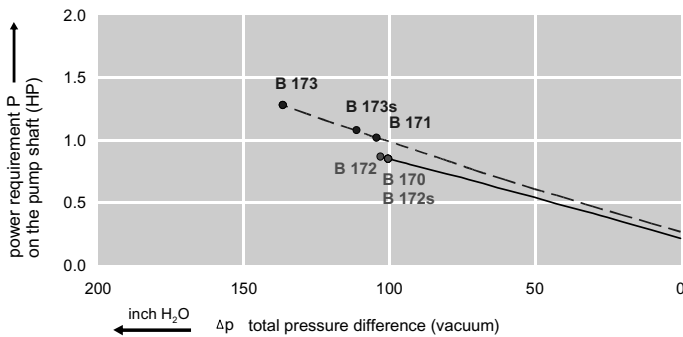
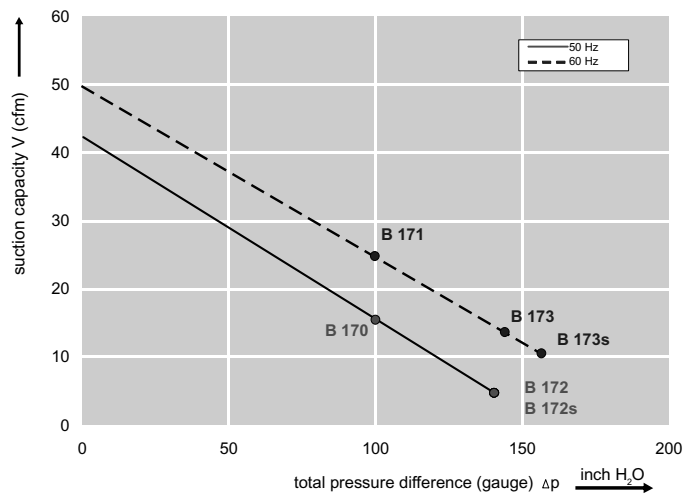

Dimensions: (inches)

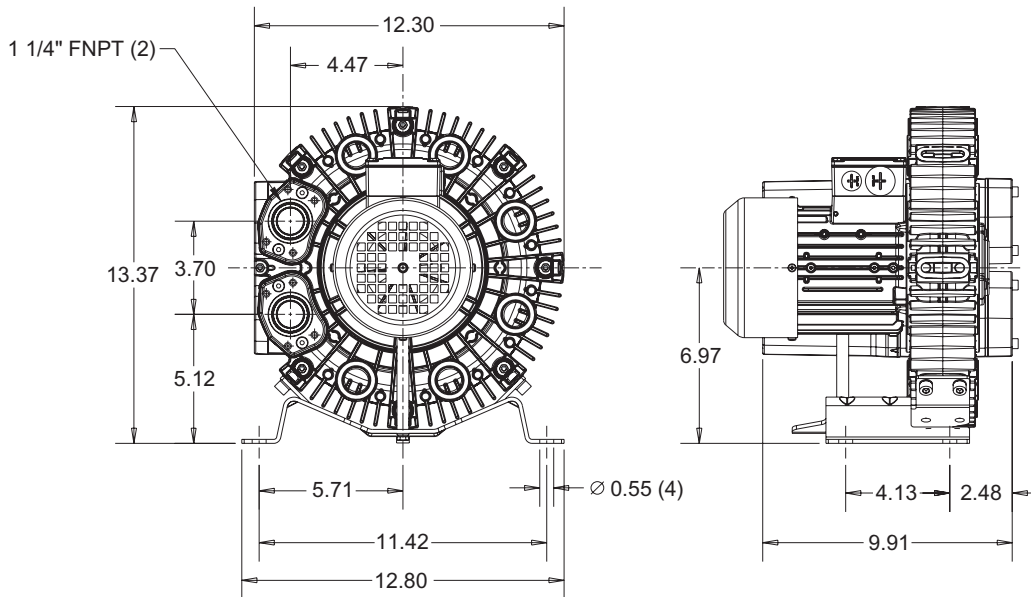

Recommended Accessories:

Relief valve:

VC51Z (Vacuum)

PC51Z (Pressure)

Filter:

ATF-125-1337
(Vacuum)

AF-S20-125-10
(Pressure)

Specifications subject to change without notice. Please contact factory for specification updates.

Selection & Ordering Data - Type 3BA7310

Curve No.	Order No.	Fre- quency Hz	Rated power HP	Input voltage		Input current		Permissible total differential pressure		Sound pressure level dB(A)	Weight lbs
				V		A		Vacuum inch H2O	Compressor inch H2O		
3~ 50/60 Hz IP55 insulation material class F											
B 170	3BA7310-0AT16	50	0.73	200D ... 240D	345Y ... 415Y	2.8 D	1.6 Y	-100	100	57	35
B 171	3BA7310-0AT16	60	1.11	220D ... 250D	415Y ... 460Y	3.75D	2.15Y	-104	100	62	35
B 172	3BA7310-0AT26	50	1.09	200D ... 240D	345Y ... 415Y	4.0 D	2.3Y	-112	141	57	37
B 173	3BA7310-0AT26	60	1.26	220D ... 250D	415Y ... 460Y	4.0 D	2.3Y	-136	145	62	37
1~ 50/60 Hz IP55 with attached capacitor for continuous operation											
B 172s	3BA7310-0AS75	50	1.26	115	230	15.2	7.6	-100	141	57	40
B 173s	3BA7310-0AS75	60	1.47	115	230	18.0	9.0	-112	157	62	40

Suitable for 208 Volt Operation