

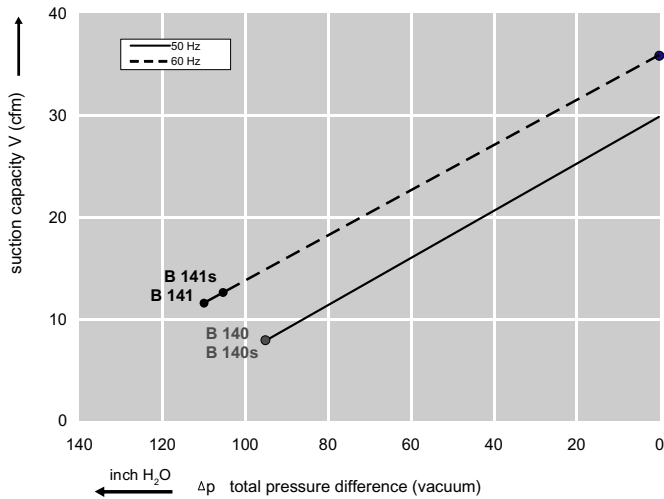

Features:

- Cooler running, outboard bearing provides maintenance-free operation
- Environmentally friendly oil-free technology
- Extremely quiet operation
- All motors are standard TEFC with Class F insulation, UL recognized, CE Compliant
Explosion-Proof motors available
- Custom construction blowers are available
- Rugged die cast aluminum construction

Performance curve for Vacuum pump



Performance curve for Compressor

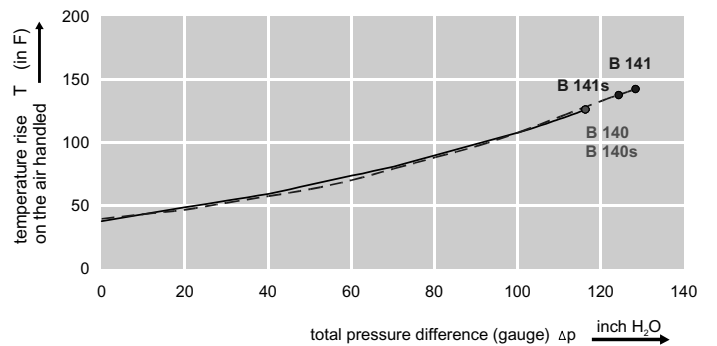
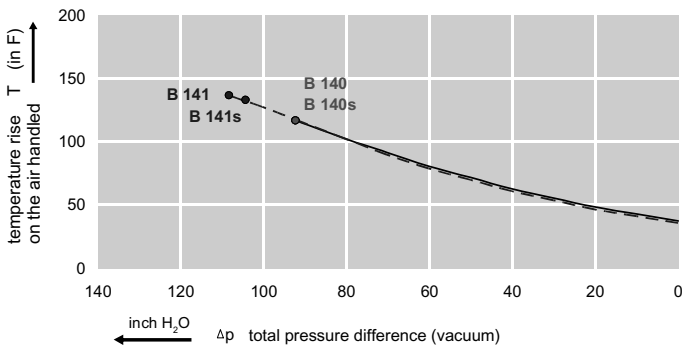
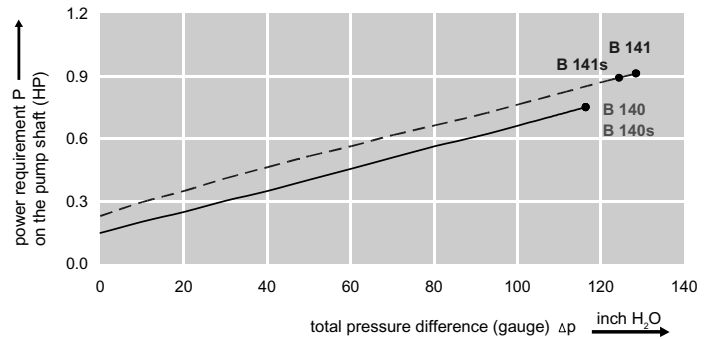
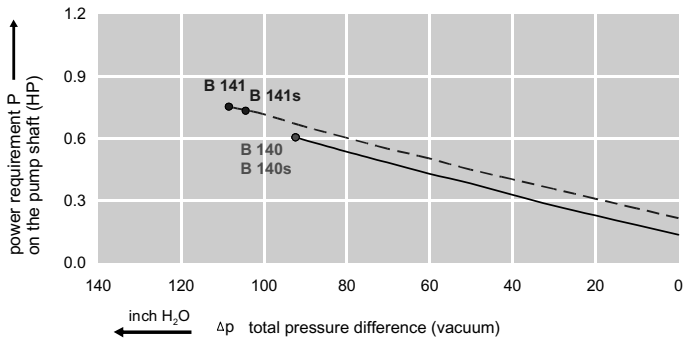
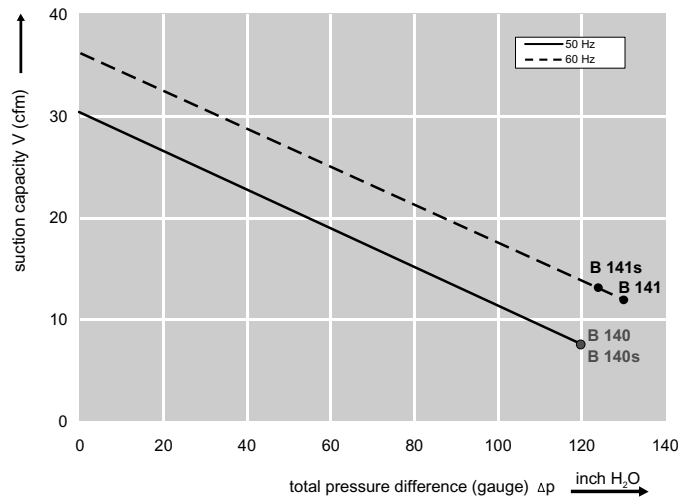

Dimensions: (inches)

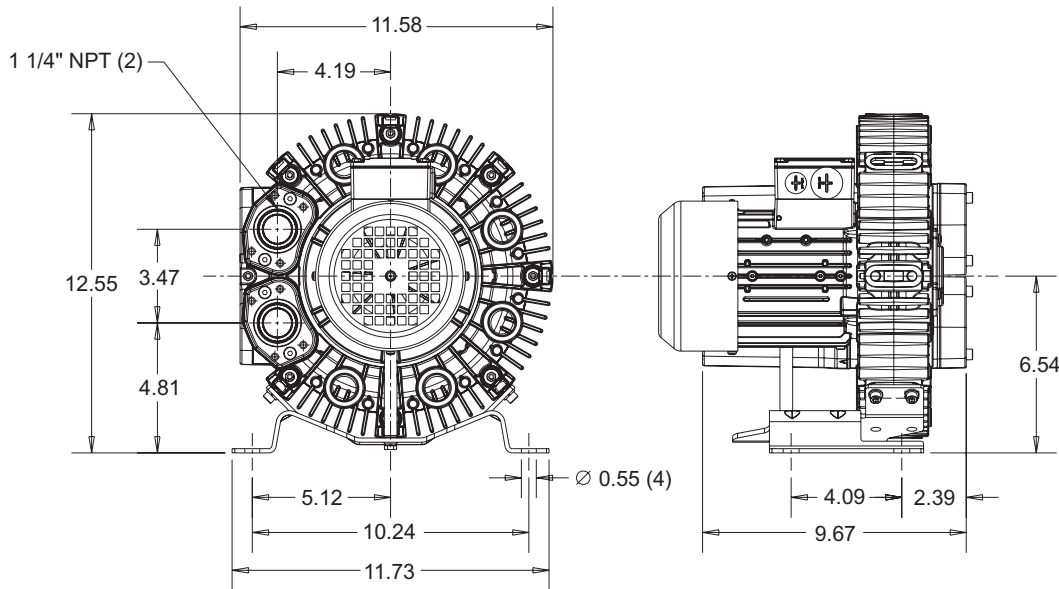

Recommended Accessories:

Relief valve:

VC51Z (Vacuum)
PC51Z (Pressure)

Filter:

ATF-125-1337
(Vacuum)
AF-S20-125-10
(Pressure)

Specifications subject to change without notice. Please contact factory for specification updates.

Selection & Ordering Data - Type 3BA7210

Curve No.	Order No.	Fre- quency Hz	Rated power HP	Input voltage		Input current		Permissible total differential pressure		Sound pressure level dB(A)	Weight lbs
				V		A		Vacuum inch H2O	Compressor inch H2O		
3~ 50/60 Hz IP55 insulation material class F											
B 140	3BA7210-0AT16	50	0.73	200D ... 240D	345Y ... 415Y	2.8D	1.6Y	-92	116	57	35
B 141	3BA7210-0AT16	60	1.11	220D ... 250D	415Y ... 460Y	3.75D	2.15Y	-108	128	62	35
1~ 50/60 Hz IP55 with attached capacitor for continuous operation											
B 140s	3BA7210-0AS75	50	0.74	115	230	13.0	6.5	-92	116	57	40
B 141s	3BA7210-0AS75	60	0.84	115	230	14.2	7.1	-104	124	62	40

Suitable for 208 Volt Operation